

Service Manual

THE FISHER[®]

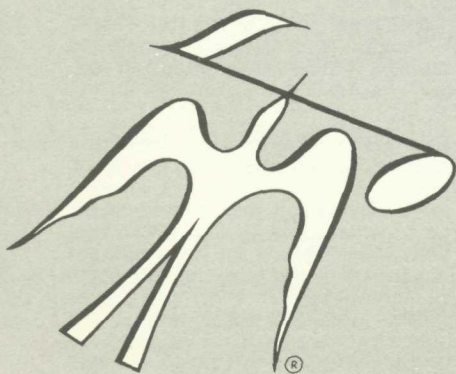

400

CHASSIS SERIAL NUMBERS
BEGINNING 48001

\$1.00

FISHER RADIO CORPORATION • LONG ISLAND CITY 1 • NEW YORK

(c) www.fisherconsoles.com

CAUTION: This is a FISHER precision high-fidelity instrument. It should be serviced only by qualified personnel — trained in the repair of transistor equipment and printed circuitry.

EQUIPMENT AND TOOLS NEEDED

The following are needed to completely test and align modern high-fidelity instruments such as amplifiers, tuners and receivers.

Test Instruments

Vacuum-Tube Volt-ohmmeter DC VTVM
Audio (AC) Vacuum-Tube Voltmeter (AC VTVM)
Oscilloscope (Flat to 100 kc minimum)
Audio (Sine-wave) Generator
Intermodulation Analyzer
Sweep (FM) Generator (88 to 108 mc)
Marker Generator
Multiplex Generator (preferably with RF output — FISHER Model 300 or equal).

Miscellaneous

Adjustable-Line-Voltage Transformer or line-voltage regulator
Load Resistors (2) — 8-ohm, 50-watt (or higher)
Stereo source (Turntable with stereo cartridge or Tape Deck)
Speakers (2) Full-range, for listening tests
Soldering iron (with small-diameter tip). Fully insulated from power line.

PRECAUTIONS

Many of the items below are included just as a reminder — they are normal procedures for experienced technicians. Shortcuts can be taken but often they cause additional damage — to transistors, circuit components or the printed-circuit board.

Soldering—A well-tinned, hot, clean soldering iron tip will make it easier to solder without damage to the printed-circuit board or the many many circuit components mounted on it. It is not the wattage of the iron that counts — it is the heat available at the tip. Low-wattage soldering irons will often take too long to heat a connection — pigtail leads will get too hot and damage the part. Too much heat, applied too long, will damage the printed-circuit board. Some 50-watt irons reach temperatures of 1,000° F — others will hardly melt solder. Small-diameter tips should be used for single solder connections — larger pyramid and chisel tips are needed for larger areas.

- When removing defective resistors, capacitors, etc., the leads should be cut as close to the body of the circuit component as possible. (If the part is not being returned for in-warranty factory replacement it may be cut in half — with diagonal-cutting pliers — to make removal easier.)
- Special de-soldering tiptlets are made for unsoldering multiple-terminal units like IF transformers and electrolytic capacitors. By unsoldering all terminals at the same time the part can be removed with little chance of breaking the printed-circuit board.
- Always disconnect the chassis from the power line when soldering. Turning the power switch OFF is not enough. Power-line leakage paths, through the heating element, can destroy transistors.

Transistors—Never attempt to do any work on the transistor amplifiers without first disconnecting the AC-power linecord — wait until the power supply filter-capacitors have discharged.

- Guard against shorts — it takes only an instant for a base-to-collector short to destroy that transistor and possibly others direct-coupled to it. [In the time it takes for a dropped machine screw, washer or even the screwdriver, to glance off a pair of socket terminals (or between a terminal and the chassis) a transistor can be ruined.]
- DO NOT bias the base of any transistor to, or near, the same voltage applied to its collector.
- DO NOT use an ohmmeter for testing transistors. The voltage applied through the test probes may be higher than the base-emitter breakdown voltage of the transistor.

Output Stage and Driver—Replacements for output and driver transistors, if necessary, must be made from the same beta group as the original type. The beta group is indicated by a colored dot on the mounting flange of the transistor. Be sure to include this information, when ordering replacement transistors.

- If one output transistor burns out (open or shorts), always remove all output transistors in that channel and check the bias adjustment, the control and other parts in the network with an ohmmeter before inserting a new transistor. All output transistors in one channel will be destroyed if the base-biasing circuit is open on the emitter end.

- When mounting a replacement power transistor be sure the bottom of the flange, the mica insulator and the surface of the heat sink are free of foreign matter. Dust and grit can prevent perfect contact. This reduces heat transfer to the heat sink. Metallic particles can puncture the insulator and cause shorts — ruining the transistor.

- Silicone grease must be used between the transistor and the mica insulator and between the mica and the heat sink for best heat conduction. Heat is the greatest enemy of electronic equipment. It can shorten the life of transistors, capacitors and resistors. (Use Dow-Corning DC-3 or C20194 or equivalent compounds made for power transistor heat conduction.)

- Use care when making connections to speakers and output terminals. Any frayed wire ends can cause shorts that may burn out the output transistors — they are direct-coupled to the speakers. There is no output transformer — nothing to limit current through the transistors except the fuses. To reduce the possibility of shorts at the speakers, lugs should be used on the exposed ends — at least the ends of the stranded wires should be tinned to prevent frayed wire ends. The current in the speakers and output circuitry is quite high. Any poor contact or small-size wire, can cause power losses in the speaker system. Use 14 or 16 AWG for long runs of speaker-connecting wiring.

DC-Voltage Measurements—These basic tests of the transistor circuitry are made without the signal generator. Without any signal input measure the circuit voltages — as indicated on the schematic. The voltage difference between the base and the emitter should be in the millivolt range — a sensitive DC meter is needed for these readings. A low-voltage range of 1 volt, full scale — or lower — is needed.

Audio-Voltage (gain) Measurements—The schematic and printed-circuit board layout diagrams are used. Input signals are injected at the proper points — found most quickly by using layout of the printed-circuit board instead of the schematic. An AUDIO (AC) VTVM connected to the test points should indicate voltages close to those values shown in the boxes on the schematic. Many of the signal levels in the input stages are only a few millivolts — they can not be read on the AC ranges supplied on most Vacuum-Tube AC/DC Volt-ohmmeters (VTVMs). Even with a 1-volt range a signal level of 100 millivolts (.1 volt) will be the first 1/10 of the meter scale. A reading of 1 millivolt (.001 volt) will hardly even move the meter needle.

DIAL STRINGING PROCEDURE

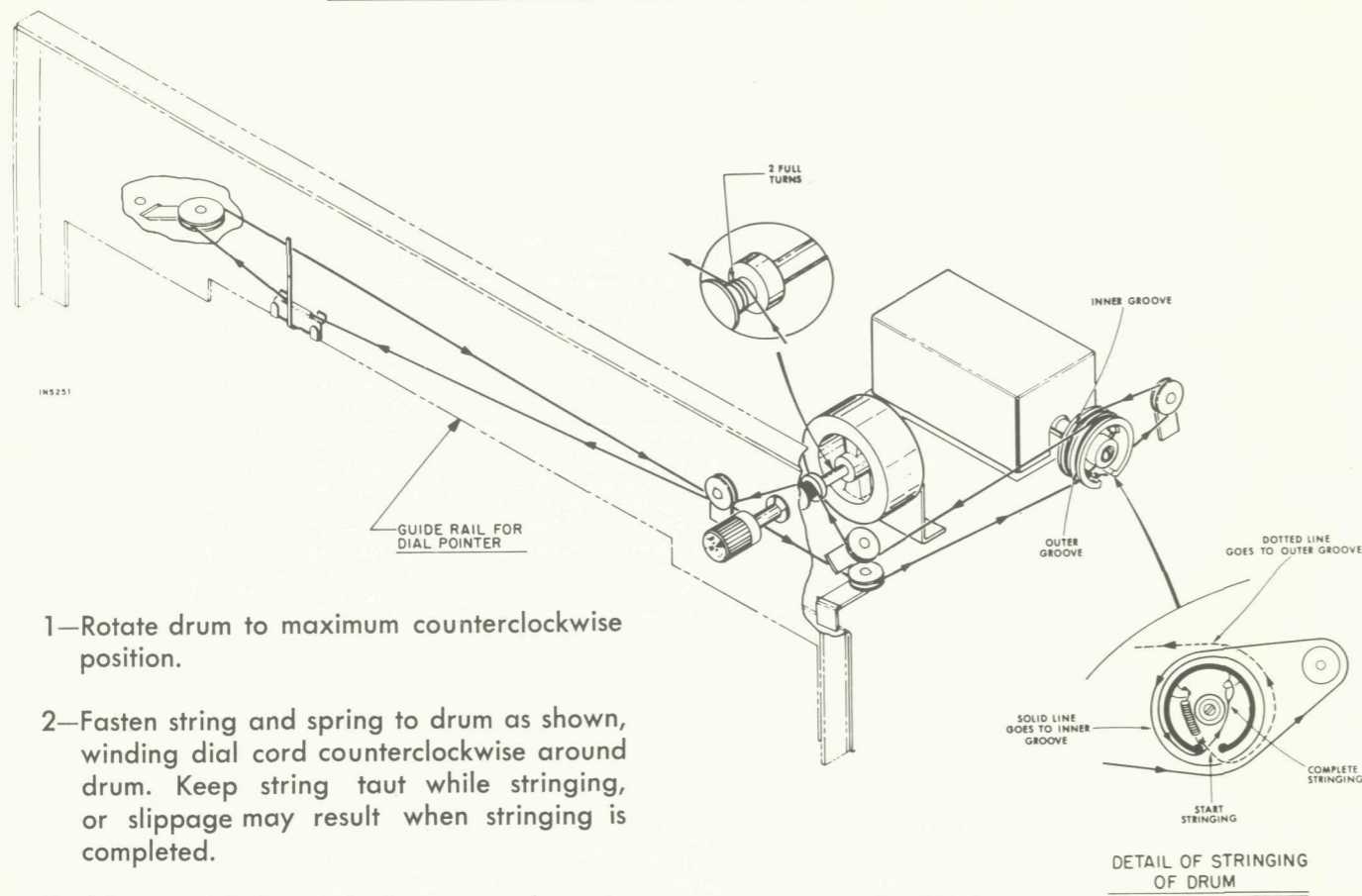

- 1—Rotate drum to maximum counterclockwise position.
- 2—Fasten string and spring to drum as shown, winding dial cord counterclockwise around drum. Keep string taut while stringing, or slippage may result when stringing is completed.
- 3—After completing stringing, set pointer to zero (0) on the dial logging scale, and glue pointer to dial cord.

If replacement parts are out of stock, locally, they may be obtained directly from the Parts Department of FISHER Radio Corporation. They will be shipped "best way", either prepaid or C.O.D. unless otherwise specified.

For instrument-operation information and technical assistance write Richard Hamilton, Customer Relations Department, FISHER Radio Corporation, Long Island City, New York 11101.

PHASE INVERTER ADJUSTMENT

- LEFT CHANNEL**
- 1 — Connect a 16-ohm load between the Left Speaker terminals. Connect the Left Impedance Selector to the "16" terminal.
 - 2 — Connect the input of the IM Distortion Analyzer across the 16-ohm load.
 - 3 — Connect the IM Distortion Analyzer output to the Left AUX input jack.
 - 4 — Set the Selector switch to AUX and adjust the Analyzer for 14 volts across the 16-ohm load.
 - 5 — Adjust the Left Phase Inverter Adjust control for minimum IM distortion.
- RIGHT CHANNEL**
- 1 — Connect a 16-ohm load between the Right Speaker terminals. Connect the Right Impedance Selector to the "16" terminal.
 - 2 — Connect the input of the IM Distortion Analyzer across the 16-ohm load.
 - 3 — Connect the IM Distortion Analyzer output to the Right AUX input jack.
 - 4 — Set the Selector switch to AUX and adjust the Analyzer for 14 volts across the 16-ohm load.
 - 5 — Adjust the Right Phase Inverter Adjust control for minimum IM distortion.

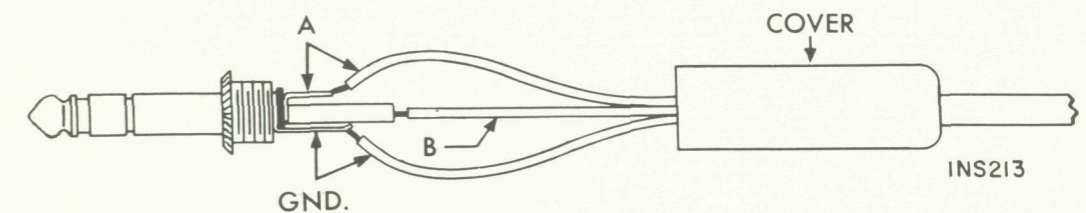

CONNECT GND TO COMMON OR GROUND TERMINAL OF HEADPHONES; **A** TO HOT TERMINAL OF LEFT CHANNEL; **B** TO HOT TERMINAL OF RIGHT CHANNEL.

Headphone plug wiring

TROUBLESHOOTING GUIDE

Does not go on (pilot or dial lamps do not light).

- Check:
- Fuse F1.
 - AC plug and line cord.
 - Wall outlet.
 - Power switch S6 (use test lamp in AC OUTLET on rear of chassis).

Fuse blows as soon as replaced.

- Check:
- CR1, CR2, CR3; C56, C57C, C60, C63 in power supply.
 - C43, C45, C47, C49, C62 filament bypass capacitors.

Distortion (both channels) in any position of SELECTOR switch.

Hum, Weak or No audio output

- Set BALANCE, TREBLE and BASS controls to NORMAL.
- Remove plugs from rear-chassis RCRDR OUT and TAPE MON jacks.
- Remove plugs from SPACEEXPANDER jacks and insert jumpers (a must).
- Remove plugs from rear-chassis PHONO, TAPE HEAD and AUX jacks.

- Test:
- V10, V11 or substitute. (Filament leakage test for hum – gas test for distortion.)
 - Supply voltage at: CR2, C56, R41; C56, C57C, R43; C57B, R42, R43; C57A, R42; C52D, R40, R41; C52C, R39, R40; C52B, R38, R39; C52A, R33, R38.
 - Bias-supply voltages at: CR1, C60A, C60B; C42, R34, R35.
 - DC Filament-supply voltage.

Distortion (LEFT channel only) in any position of SELECTOR.

Hum, Weak or No Audio output

- Remove plugs from rear-chassis RCRDR OUT and TAPE MON jacks (left channel).
- Remove plug from SPACEEXPANDER jack (left channel) and insert jumper (a must).

- Check:
- Position of BALANCE, TREBLE and BASS controls (set to NORMAL positions).
 - Position of PHASE INVERTER ADJ. (R107).

- Test:
- V12, V14, V15 or substitute. (Filament leakage test for hum – gas test for distortion.)
 - Voltages at sockets for V10, V11, V12, V14, V15.

Distortion (RIGHT channel only) in any position of SELECTOR.

Hum, Weak or No audio output

- Remove plugs from rear-chassis RCRDR OUT and TAPE MON jacks (right channel).
- Remove plug from SPACEEXPANDER jack (right channel) and insert jumper (a must).

- Check:
- Position of BALANCE, TREBLE and BASS controls (set to NORMAL positions).
 - Position of PHASE INVERTER ADJ. (R108).

- Test:
- V13, V16, V17 or substitute. (Filament leakage test for hum–gas test for distortion.)
 - Voltages at sockets for V10, V11, V13, V16, V17.

Distortion (LEFT channel only) PHONO and TAPE HEAD positions of SELECTOR.

Hum, Weak or No audio output

- Remove plugs from rear-chassis PHONO and TAPE HEAD jacks (for hum).
- Switch LEFT channel plug to RIGHT channel jack (for distortion, weak or no audio output).

- Check:
- Jack, plugs and interconnecting cables.
 - Phono cartridge, or tape head output.

- Test:
- V8 or substitute. (Filament leakage test for hum–gas test for distortion.)

Distortion (RIGHT channel only) PHONO and TAPE HEAD positions of SELECTOR.

Hum, Weak or No audio output

- Remove plugs from rear-chassis PHONO and TAPE HEAD JACKS (for hum).
- Switch RIGHT channel plug to LEFT channel jack. (for distortion, weak or no audio output).

- Check:
- Jack, plugs and interconnecting cables.
 - Phono cartridge, or tape head output.

- Test:
- V8 or substitute. (Filament leakage test for hum–gas test for distortion.)

Distortion (BOTH channels) all FM positions of SELECTOR.

Hum, Weak or No audio output

- Tune to other FM stations—watch tuning indicator.

- Check:
- Antenna position and connections.
 - IF and RF alignment.

- Test:
- V1, V2, V3, V4, V5, V6 or substitute.
 - (Filament leakage test for hum–gas test for distortion.)
 - Voltages at sockets for V1, V2, V3, V4, V5, V6 and ratio detector.

Distortion (BOTH channels) FM STEREO positions of SELECTOR only.

- Tune to other FM-Stereo stations—watch tuning indicator.

- Check:
- Antenna position and connections.
 - MPX, IF and RF alignment.

- Test:
- Voltages at sockets for V1, V2, V3, V4, V5 V6 and ratio detector.
 - V100, V101, V102 or substitute. (Filament leakage test for hum–gas test for distortion.)
 - Voltages at MPX-decoder tube sockets V100, V101, V102.

MULTIPLEX DECODER ALIGNMENT

STEPS	GENERATOR			INDICATOR	ALIGNMENT		
	CONNECTION	AUDIO FREQUENCY	RF MODULATION	TYPE & CONNECTION	ADJUST	INDICATION	NOTES
1	Audio oscillator connected to lug 1	80 KC—1 volt	None	AC VTVM to junction of C210 and R228	L100 (Use hex alignment tool)	Minimum voltage	
2	Multiplex generator audio output to lug 1 (See Note 1)	19 KC (± 5 cps) pilot tone, 100 mv	None	DC VTVM to T.S.P. 101	Z100 top and bottom (Use hex alignment tool)	Maximum voltage	1
3	Same as Step 2	19 KC pilot tone, 50 mv	None	Scope horiz. input to 19 KC output of gen.; vert. input to junction of C216 and R209. External sweep	Z101 (Use K-tran alignment tool)	Stable 2:1 Lissajous pattern. Disregard phase of pattern	1
4	Same as Step 2	19 KC	None	Same as Step 3	Vary generator 19 KC output from 50 to 200 mv	Lissajous pattern should remain stationary over the entire 150 mv range	1, 2
5	Same as Step 2	1000 cps on left (A) channel only, 1 volt rms (2.8 P-P)	None	AC VTVM and scope vert. input to channel A output lug. Internal sweep. DC VTVM to T.S.P. 101	Z100 top (Use hex tool)	Maximum indication on AC VTVM. Clean 1000 cps waveform on scope	1, 3
6	Same as Step 2	1000 cps on right (B) channel only, 1 volt rms (2.8 P-P)	None	Same as Step 5	MPX separation R215	Minimum reading on AC VTVM should be at least 33 db below reading obtained in Step 5	1
7	Same as Step 2	Same as Step 6	None	Move scope input and AC VTVM to channel B output lug	-----	Note and record voltage reading on AC VTVM	1
8	Same as Step 2	1000 cps on left (A) channel only, 1 volt rms (2.8 P-P)	None	Same as Step 7	-----	AC VTVM reading should be at least 33 db below reading observed in Step 7	1
9	Same as Step 2	8000 cps on right (B) channel only, 1 volt rms (2.8 P-P)	None	Same as Step 7	-----	AC VTVM reading should be the same as observed in Step 7	1
10	Same as Step 2	8000 cps on left (A) channel only, 1 volt rms (2.8 P-P)	None	Same as Step 7	-----	AC VTVM reading should be at least 18 db below reading observed in Step 9	1
11	Repeat Steps 9 and 10 with scope and AC VTVM connected to channel A output lug, but start with 8000 cps applied to left channel for first reading, then switch to right channel for second reading.						
12	Multiplex generator RF output to 300-ohm antenna terminals	1000 cps on left (A) channel only	100% (75 KC Dev.) No pre-emphasis	Move scope input and AC VTVM to channel A output lug	-----	Note and record voltage reading on AC VTVM	4
13	Same as Step 12	1000 cps on right (B) channel only	Same as Step 12	Same as Step 12	R215	Minimum reading on AC VTVM should be at least 33 db below reading observed in Step 12	4
14	Same as Step 12	8000 cps on left (A) channel only	Same as Step 12	Same as Step 12	-----	AC VTVM reading should be 10 db below reading observed in Step 12	4
15	Same as Step 12	8000 cps on right (B) channel only	Same as Step 12	Same as Step 12	-----	AC VTVM reading should be 28 db below reading observed in Step 12	4

NOTE: The above procedure is based on the use of the FISHER Model 300 Multiplex Generator.

1 — In steps 2 through 11, the audio output of the Multiplex Generator should be connected to lug 1 of the multiplex sub-chassis through a 12,000 ohm, 1/2-watt, carbon resistor, and a 180 uuf capacitor should be connected between lug 1 and ground. The wiring from the MPX TEST jack on the main chassis to lug 1 must be disconnected during Steps 2 through 11.

2 — The vertical amplitude of the Lissajous pattern will increase slightly

as the generator output is increased. This is a normal occurrence.

3 — If DC VTVM reading falls below —9 volts when maximum reading is obtained on the AC VTVM, readjust bottom of Z100, then repeat Step 5. Repeat this procedure until maximum AC VTVM reading is obtained with DC VTVM reading greater than —9 volts.

4 — Tune the FISHER to the RF output frequency of the Multiplex Generator.

1007 MULTIPLEX DECODER

CAPACITORS

10% tolerance for all fixed capacitors, unless otherwise noted or marked GMV (guaranteed minimum value). All capacitors not marked uf are pF (puf).

Symbol	Description	Part No.
C200	Ceramic, .01uf, +80 -20%, 500V	C50089-7
C201	Ceramic, 680, 1000V	C50072-2
C203	Ceramic, 220, 1000V	C50183-3
C204	Polystyrene, 470, 5%, 500V	C50394-1
C205	Ceramic, 82, 1000V	C50070-1
C206	Ceramic, 1000, GMV, 500V	C50089-2
C207	Ceramic, 5000, +80 -20%, 500V	C50089-6
C208, 209	Mica, 4700, 5%, 500V	C50332-5
C210	Electrolytic, 1uf, 350V	C50283-3
C211	Ceramic, 1000, GMV, 500V	C50089-2

C212	Ceramic, 5000, 20%, 500V *Ceramic, .05uF, +80% -20%	C50089-1 C50073-2
C214	Mylar, 4700, 400V	C50197-25
C215	Mica, 3900, 5%, 500V	C50332-6
C216, 217	Ceramic, 1000, GMV, 500V	C50089-2
C218	Ceramic, .02uf, 20%, 500V	C50089-5
C219	Ceramic, 330, 1000V	C50183-5
C220	Ceramic, .02uf, 20%, 500V	C50089-5
C221, 222	Mylar, .047uf, 250V	C50197-52
C223, 224	Ceramic, 1000, 1000V	C50072-3
C225, 226	Ceramic, 2200, 1000V	C50072-5

RESISTORS

In ohms, 5% tolerance, 1/8 W unless otherwise noted. K=Kilohms, M=Megohms.

Symbol	Description	Part No.
R200	Composition, 22M, 10%, 1/2 W	RC20BF226K

R201	Composition, 4.7K, 1/2 W	RC20BF472J
R202	Composition, 15K, 1/2 W	RC20BF153J
R203	Composition, 10M, 10%, 1/2 W	RC20BF106K
R204	Dep. Carbon, 1M	R12DC105J
R205	Dep. Carbon, 220K, 1/2 W	R33DC224J
R206	-Deleted-	- - -
R207, 208, 209	Dep. Carbon, 1M	R12DC105J
R210	Dep. Carbon, 22K	R12DC223J
R211, 212	-Deleted-	- - -
R213, 214	Dep. Carbon, 100K	R12DC104J
R215	Potentiometer, 50K, MPX Separation	R50150-4
R216	Composition, 22M, 10%, 1/2 W	RC20BF226K
R217, 218	Dep. Carbon, 18K, 1/2 W	R33DC183J
R219, 220	Dep. Carbon, 15K, 1/2 W	R33DC153J
R221	Composition, 22M, 10%, 1/2 W	RC20BF226K

MISCELLANEOUS

Symbol	Description	Part No.
CR100	Diode, Type 1112	V1112
CR102, 103	Diode Bridge	V50260-13DX
L100	Coil, low pass	L50210-30
L101	Coil, 5.25MH	L50334-1
L102, 103	Coil, 20MH	L50334-2
Z100	Transformer, 19Kc	ZZ50210-34
Z101	Coil, 38Kc	ZZ50210-33

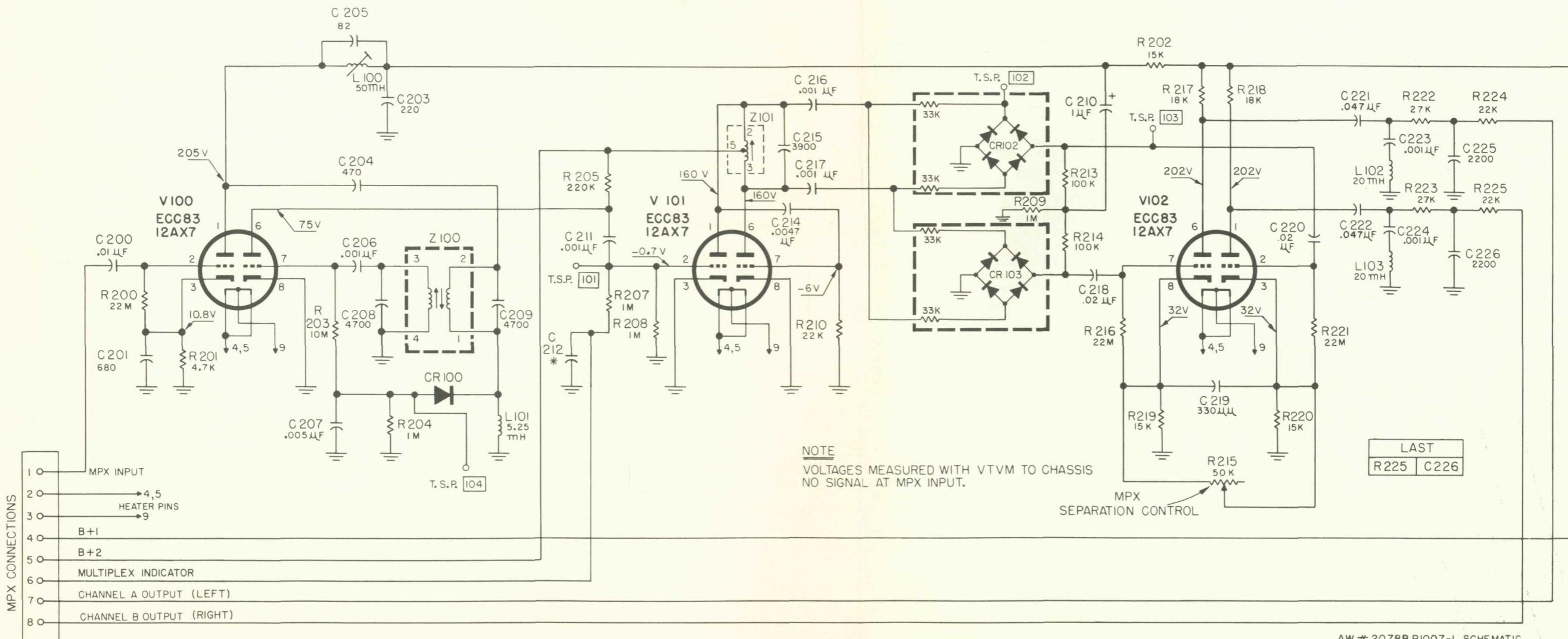

NOTE
VOLTAGES MEASURED WITH VTVM TO CHASSIS
NO SIGNAL AT MPX INPUT.

LAST
R225 C226

* SEE PARTS LIST

AW # 2078B P1007-1 SCHEMATIC
MPX 65

MAIN CHASSIS • PARTS DESCRIPTION LIST

CAPACITORS

10% Tolerance for all fixed capacitors, unless otherwise marked or noted GMV (guaranteed minimum value). All capacitors not marked uF are pF (uF).

Symbol	Description	Part No.
C1	Ceramic, 21, 5%, N750, 1000V	C50070-32
C2	Ceramic, 8, 5%, NPO, 1000V	C50070-45
C3	Ceramic, Trimmer	C662-123
C4	Ceramic, 1000GMV, 500V	C50089-2
C5, A, B, C	Variable, FM Tuning	C966-109-1
C6	Ceramic, 39, N1500, 1000V	C50070-17
C7	Ceramic, 24, 5%, N150, 1000V	C50070-8
C8	Ceramic, 1000, GMV, 500V	C50089-2
C9	Ceramic, 12, N080, 5%, 500V	CC20LJ120J5
C10	Ceramic, Trimmer	C662-123
C11	Ceramic, 8, 5%, NPO, 1000V	C50070-45
C12	Ceramic, 13, NPO, 5%, 500V	CC20CJ130J5
C13	Ceramic, 120, 5%, N1500, 1000V	C50070-44
C14, 15, 16, 17	Ceramic, Feedthru, 1000	C592-187
C18	Ceramic, .02uF, +80 -20%	C50095-1
C19	Ceramic, 2700, 1000V	C50072-17
C20	Ceramic, 560, 1000V	C50072-14
C21, 22	Ceramic, 5000, +80 -20%, 500V	C50089-6
C23	Ceramic, 2700, 1000V	C50072-17
C24	Ceramic, 5000, +80 -20%, 500V	C50089-6
C25	Ceramic, 24, 5%, 1000V	C50070-8
C26	Ceramic, .02uF, +80 -20%, 100V	C50095-1
C27	Ceramic, .02uF, GMV, 1000V	C50071-6
C28	Ceramic, 2700, 1000V	C50072-17
C29	Ceramic, .02uF, GMV, 1000V	C50071-6
C30	Ceramic, 5000, +80 -20%, 500V	C50089-6
C31	Ceramic, 18, N470, 1000V	C50070-13
C32	Mylar, .1uF, 125V	C50435-7
C33	Ceramic, 1000, 1000V	C50072-3
C34	Ceramic, .02uF, +80 -20%, 500V	C50089-4
C35	Ceramic, 2700, 1000V	C50072-17
C36	Ceramic, .02uF, GMV, 1000V	C50071-6
C37	Ceramic, 5000, +80 -20%, 500V	C50089-6
C38	Ceramic, 1800, 1000V	C50072-8
C39, 40	Ceramic, 330, 1000V	C50072-1

C41	Electrolytic, 8uF, 50V	C629-138
C42	Electrolytic, 100uF, 25V	C50483-6
C43, 44	Ceramic, .02uF, +80 -20%, 500V	C50089-4
C45, 46, 47, 48, 49, 50	Ceramic, 5000, +80 -20%, 500V	C50089-6
C51	-Deleted-	- - -
C52	Electrolytic, 4-Section A- 20uF, 300V B- 40uF, 400V C- 40uF, 450V D- 40uF, 500V	C50180-49
C53, 54, 55	-Deleted-	- - -
C56	Electrolytic, 100uF, 300V	C50180-43
C57	Electrolytic, 3-Section A- 50uF, 250V B- 50uF, 250V C- 200uF, 300V	C50180-51
C58, 59	-Deleted-	- - -
C60	Electrolytic, 2-Section A- 1000uF, 35V B- 1000uF, 35V	C50180-38
C61	-Deleted-	- - -
C62	Ceramic, Feedthru, 1000	C592-187
C63, 64	Molded, .01uF, 20%, 600V	C2747
C65, 66	Ceramic, 100 GMV, N1500, 1000V	C50070-5
C67, 68	Ceramic, .01uF, 20%, 500V	C50089-3
C69, 70	Mylar, .047uF, 400V	C50197-49
C71, 72	Ceramic, 120, N1500, 1000V	C50070-9
C73	Ceramic, 18, N470, 1000V	C50070-13
C74	Ceramic, 24, 5%, 1000V	C50070-8
C75, 76	Ceramic, 1000, 1000V	C50072-3
C77, 78	Ceramic, .02uF, 20%, 500V	C50089-4
C79, 80	Ceramic, 56, 5%, N1500, 1000V	C50070-38
C81, 82	Mylar, .047uF, 400V	C50197-30
C83, 84	Ceramic, 560, 1000V	C50072-14
C85, 86	Ceramic, 68, N2200, 1000V	C50070-12
C87, 88	Ceramic, .02uF, 20%, 500V	C50089-5
C89, 90	Ceramic, 2, NPO, 1000V	C50070-23
C91, 92	Ceramic, 560, 1000V	C50072-14
C93, 94	Mylar, .047, 630V	C50197-101
C95, 96	Mylar, .047, 400V	C50197-30
C97, 98	Ceramic, 18, N470, 1000V	C50070-13
C99, 100	Ceramic, 330, 1000V	C50072-1

R41	Glass, 1.2K, 10%, 7W	
R42, 43	Glass, 330, 10%, 3W	
R44	Composition, 820K, 10%, 1/2W	
R45, 46	220K	
R47, 48	150K	
R49, 50	68K	
R51, 52	100K	
R53, 54	10	
R55, 56	10K	
R57, 58	Glass, 2.7K, 5%, 1/2W	
R59, 60	Glass, 330K, 5%, 1W	
R61, 62	4.7M, 1/3W	
R63, 64	220K, 1/3W	
R65, 66	330K	
R67, 68	82K	
R69, 70	330K	
R71, 72	470K	
R73, 74	1.5M, 1/3W	
R75, 76	2.7M, 1/3W	
R77, 78	120K, 1/3W	
R79, 80	1K	
R81, 82	680K	
R83A, B	Pot., 500K, Dual, Treble	
R84A, B	Pot., 500K, Dual, Bass	
R85, 86	120K, 1/3W	
R87, 88	1K	
R89, 90	220K	

RPG7W122K	
RPG3W331K	
RC20BF824K	
R12DC224J	
R12DC154J	
R12DC683J	
R12DC104J	
R12DC100J	
R12DC103J	
R20G272J	
R30G334J	
R33DC475J	
R33DC224J	
R12DC334J	
R12DC823J	
R12DC334J	
R12DC474J	
R33DC155J	
R33DC275J	
R33DC124J	
R12DC102J	
R12DC684J	
R50160-136-1	
R50160-136-2	
R33DC124J	
R12DC102J	
R12DC224J	

R91, 92	2.7M, 1/3W
R93, 94	47K
R95	Pot., 500K, Balance
R96, 97	22K
R98A, B	Pot., 500K, Dual, Volume
R99, 100	47K
R101, 102	390K
R103, 104	1.2K
R105, 106	220
R107, 108	Potentiometer, 500K
R109, 110	47K, 1/3W
R111, 112	120K, 1/3W
R113, 114	2.7K
R115, 116	150K, 1/3W
R117, 118, 119, 120	330K
R121, 122, 123, 124	1K, 1/3W
R125	4.7K, 1/3W
R126, 127	Wirewound, 25, 10%, 5W
R128, 129	2.2K, 1/3W
R130, 131	Composition, 330, 10%, 1/2W
R132, 133	470K
R134, 135	Composition, 1K, 10%, 1/2W
R136	470K
R137	Composition, 1.8M, 10%, 1/2W
R138	Wirewound, 15, 10%, 5W

R33DC275J
R12DC473J
R50160-135
R12DC223J
R50160-104
R12DC473J
R33DC394J
R12DC122J
R12DC221J
R50150-6
R33DC473J
R33DC124J
R12DC272J
R33DC154J
R12DC334J
R33DC102J
R33DC472J
R688-117
R33DC222J
RC20BF331K
R12DC474J
RC20BF102K
R12DC474J
RC20BF185K
R719-106

COILS, CHOKES, TRANSFORMERS

Symbol	Description	Part No.
L1	Coil, FM Antenna	L966-113
L2	Coil, RF	L1034-113
L3	Coil, FM Mixer	L1034-112
L4	Coil, FM Oscillator	AS1034-115
L5	Choke, 1.2 Microhenry	L50066-3
L6	Choke, .68 Microhenry	L50066-1

L7	Choke, 3.3 Microhenry	L50066-8
T1	Transformer, Power	T1020-124
T2	Transformer, Output	T1020-116-1AX
T3	Transformer, Output	T1020-116-2AX
Z1	Transformer, FM IF	ZZ50210-20
Z2	Transformer, FM IF	ZZ2987
Z3	Transformer, FM IF	ZZ50210-2
Z4	Coil, FM Limiter	ZZ50210-61
Z5	Transformer, FM Ratio Detector	ZZ50210-9

MISCELLANEOUS

Symbol	Description	Part No.
CR1	Rectifier, Silicon Bridge	SIB50B794-2
CR2, 3	Diode, Silicon	SR50411-1
F1	Fuse, 3.2 AMP, Slo-Blo	F3319
I1, I2	Lamp, Dial	I50411-4
J20	Jack, Earphone	J846-120-1
PC1, 2	Printed Circuit, Equalization	PC50187-3
PC3, 4	Printed Circuit, Tone Control	PC50187-9
PC5, 6	Printed Circuit, High Filter	PC50187-2

S1	Switch, Selector	S1020-119
S2, 3, 4, 5	Switch, Slide	S50200-5
S6	Switch, Power	Part of R98
- -	Dress. Panel, Screened	AS1020-108
- -	Antenna, FM Dipole	AS50227-1
- -	Knob, Dummy Dual	E50324
- -	Knob, Dual, Top	E50323
- -	Knob, Dual, Bottom	E50221
- -	Knob, Tuning	E50324-1
- -	Dial Glass, Screened	N1020-107
- -	Fuse Holder	X563-151

RESISTORS & POTENTIOMETERS

Deposited Carbon, in ohms, 5% Tolerance, 1/8 watt, unless otherwise noted. K=Kilohms, M=Megohms.

Symbol	Description	Part No.
R1	Composition, 270, 10%, 1/2W	RC20BF271K
R2	Composition, 100K, 10%, 1/2W	RC20BF104K
R3	1.2K	R12DC122J
R4	220K	R12DC224J
R5	150K	R12DC154J
R6	1K	R12DC102J
R7	Composition, 4.7K, 10%, 1/2W	RC20BF472K
R8	Composition, 3.9K, 10%, 1W	RC30BF392K
R9	Composition, 68, 5%, 1/2W	RC20BF680J
R10	Composition, 27K, 10%, 1/2W	RC20BF273K
R11	39K	R12DC393J
R12	Composition, 1K, 10%, 1/2W	RC20BF102K
R13	Composition, 150, 10%, 1/2W	RC20BF151K
R14	Composition, 47K, 10%, 1/2W	RC20BF473K
R15	Composition, 15K, 10%, 1/2W	R12DC153J
R16	Composition, 68K, 10%, 1/2W	RC20BF683K

R17	2.2M, 1/3W	R33DC225J
R18	820K	R12DC824J
R19	Composition, 82K, 10%, 1/2W	RC20BF823K
R20	15K	R12DC153J
R21	100K	R12DC104J
R22	3.3M, 1/3W	R33DC335J
R23	4.7M, 1/3W	R33DC475J
R24	47K	R12DC473J
R25	68K	R12DC683J
R26	470K	R12DC474J
R27	Composition, 270, 5%, 1/2W	RC20BF271J
R28	47K	R12DC473J
R29	Composition, 1.5K, 5%, 1/2W	RC20BF152J
R30	Composition, 1K, 5%, 1/2W	RC20BF102J
R31, 32	6.8K	R12DC682J
R33	Composition, 100K, 10%, 1/2W	RC20BF104K
R34	2.2K, 1/3W	R33DC222J
R35	1K, 1/3W	R33DC102J
R36, 37	Composition, 220, 10%, 1/2W	RC20BF221K
R38	Composition, 22K, 10%, 1/2W	RC20BF223K
R39	Composition, 2.2K, 10%, 1W	RC30BF222K
R40	Composition, 1.2K, 10%, 1W	RC30BF122K

RECEIVER • SCHEMATIC

SWITCH POSITIONS						
POS. NO.	S1 SELECTOR SW	S2 TAPE MONITOR SW	S3 HIGH FILTER SW	S4 LOUDNESS CONTOUR SW	S5 SPEAKER SW	S6 POWER SW
1	TAPE HEAD	OFF	OFF	OFF	OFF	OFF
2	PHONO MONO	ON	ON	ON	ON	ON
3	PHONO STEREO					
4	FM STEREO					
5	FM STEREO FILTER					
6	FM MONO					
7	AUX-TAPE					

ALL SWITCHES ARE SHOWN IN THE NO. 1 POSITION

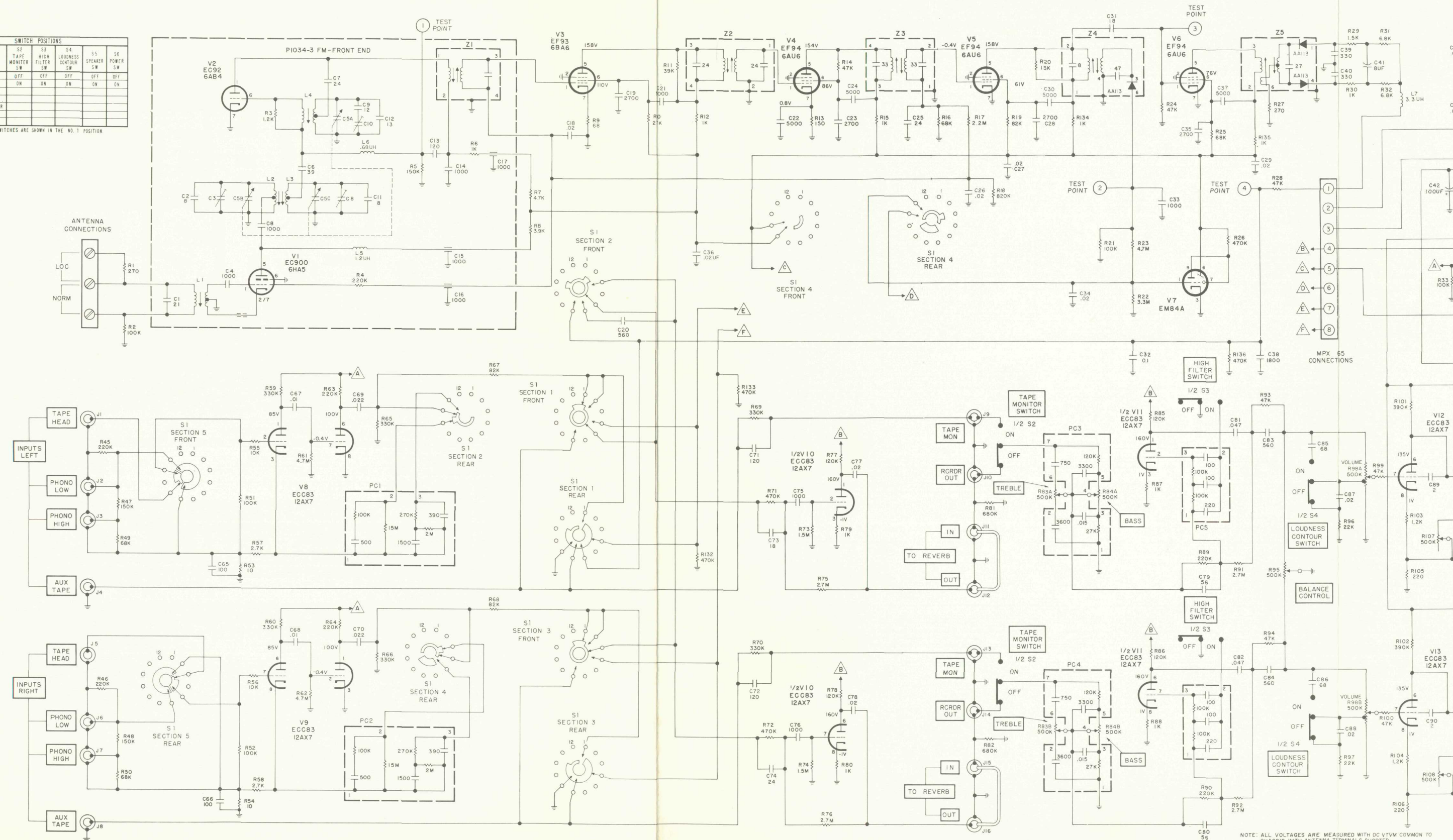

NOTE: ALL VOLTAGES ARE MEASURED WITH DC VTVM COMMON TO CHASSIS WITH ANTENNA TERMINALS SHORTED.

BECAUSE ITS PRODUCTS ARE SUBJECT TO CONTINUOUS IMPROVEMENT, FISHER RADIO CORPORATION RESERVES THE RIGHT TO MODIFY ANY DESIGN OR SPECIFICATION WITHOUT NOTICE AND WITHOUT INCURRING ANY OBLIGATION.

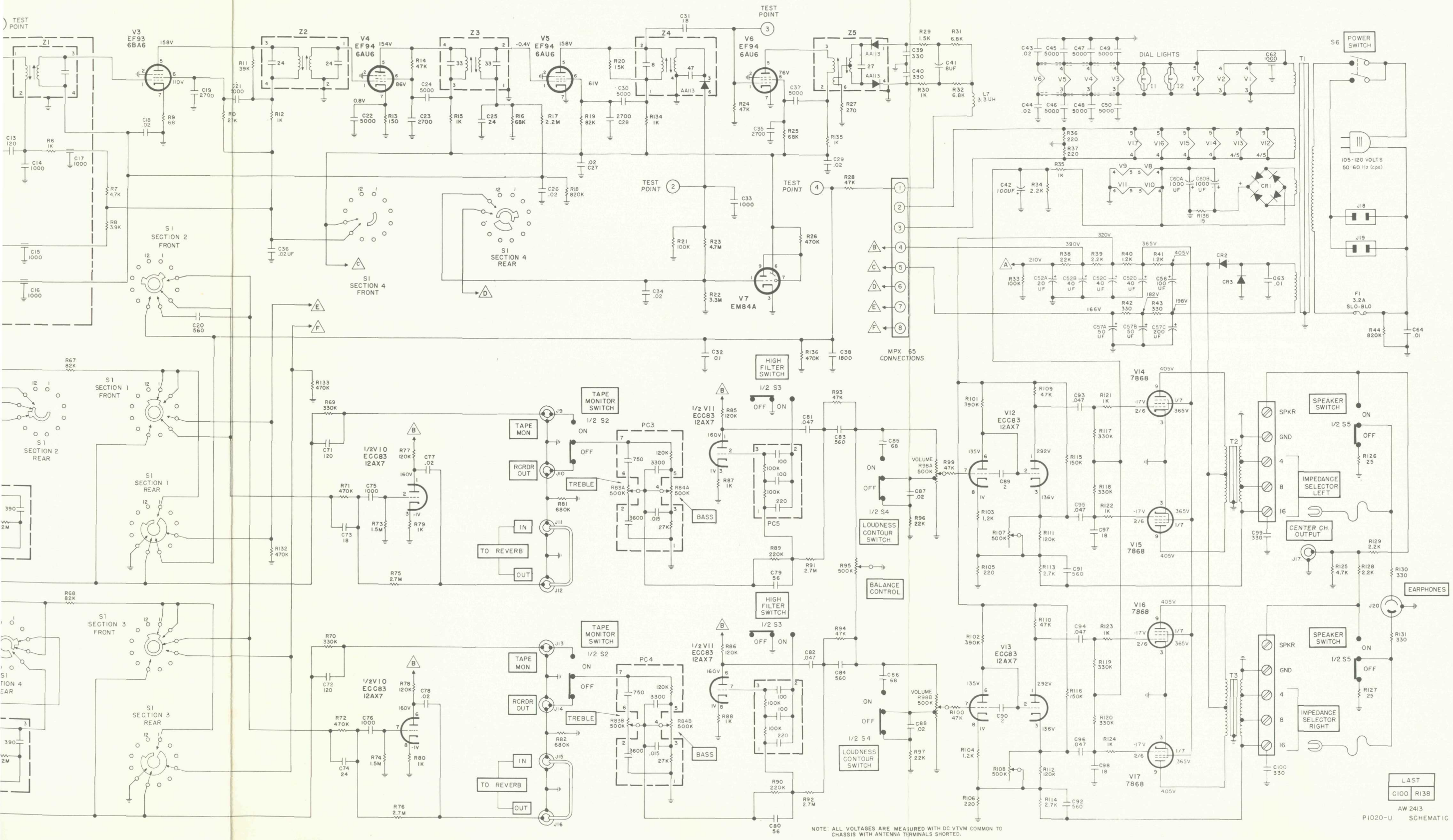

NOTE: ALL VOLTAGES ARE MEASURED WITH DC VTVM COMMON TO CHASSIS WITH ANTENNA TERMINALS SHORTED.

LAST
C100 R138
AW 2413
P1020-U SCHEMATIC

SERVICE NOTES

ALIGNMENT INSTRUCTIONS

- Set the SELECTOR switch to the MONO position for the entire alignment procedure.
- Rotate the TUNING knob to its maximum counterclockwise position. (Dial pointer must line up with the zero (0) calibration mark at the left-hand end of the logging scale without forcing—reset dial pointer if necessary.)
- Warm up the receiver and the test equipment for at least 15 minutes before beginning alignment.
- Adjust the line voltage for 117-volts, 50- to 60-Hz (cps) AC.

WARNING: Only use the proper, fully insulated, alignment tools to prevent breakage or damage to the adjustable circuit components.

NOTE: Reduce signal-generator output during alignment to keep VTVM readings below the specified voltages.

STEP	DIAL	SIGNAL GENERATOR			DC VTVM	ADJUST	INDICATION
		GENERATOR COUPLING	FREQ.	MOD.			
1	Set dial pointer for extreme C.C.W. position.	Ungrounded tube shield of V2	10.7 MHz (MC)	None	TEST POINT 3	Z1, Z2, Z3 top and bottom; Z4 bottom	Maximum negative voltage (below -5 volts)
2					---	Z4 top	Maximum indication on TUNING INDICATOR
3					Across C41	Z5 bottom	Maximum indication (below -20 volts)
4					Hot lead of DC VTVM to TEST POINT 4; Common lead to ground	Z5 top	Zero indication on zero-center dial.
5	90 MHz (MC)	Two 120-ohm carbon resistors in series with generator leads to the Normal antenna terminals.	90 MHz (MC)	±22.5 kHz (KC) deviation at 400 cps	Through 100K resistor to TEST POINT 2	L4, L3 and L2	Adjust for maximum negative voltages and check for sine wave-form, with scope at Left or Right RCRDR output.
6	106 MHz (MC)		106 MHz (MC)	±22.5 kHz (KC) deviation at 400 cps	Through 100K resistor to TEST POINT 2	C10, C8 and C3	
7	98 MHz (MC)		98 MHz (MC)	±22.5 kHz (KC) deviation at 400 cps	Through 100K resistor to TEST POINT 2	L1	
8	Repeat steps 6 and 7 for proper dial calibration and maximum output.						

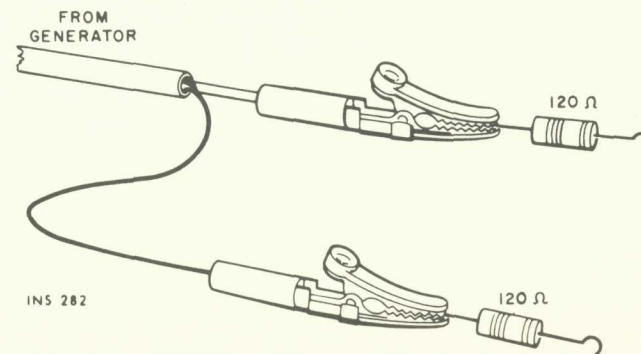

CHASSIS LAYOUT

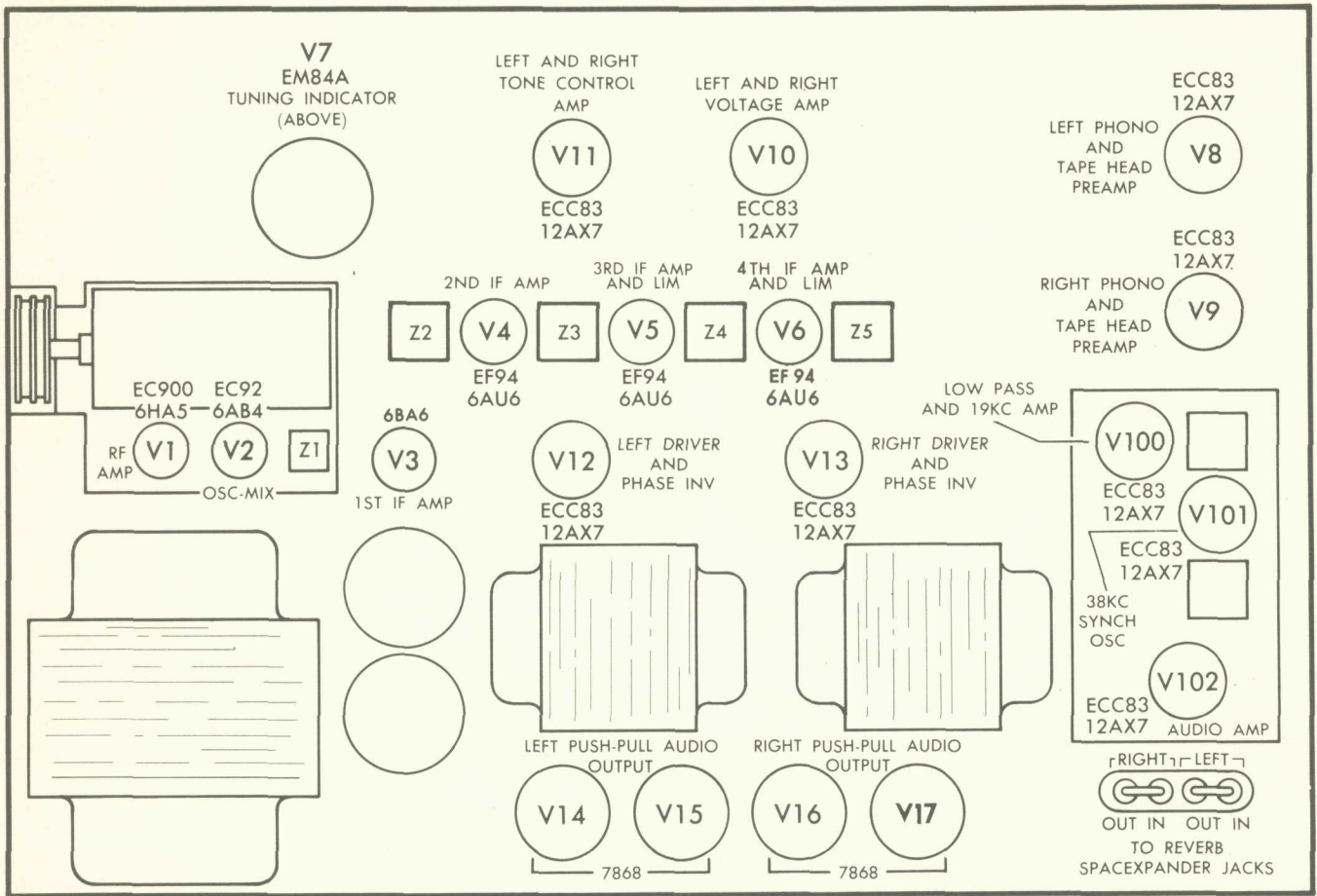

NOTE: IMPEDANCE SELECTOR SHOWN IN 16-OHM CONNECTION

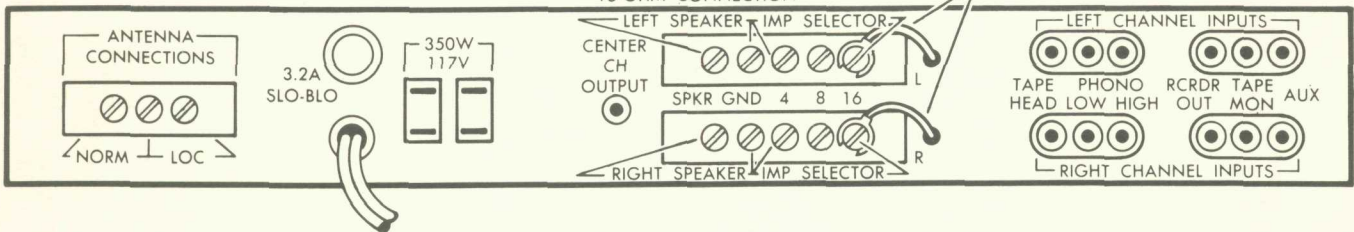

INS 174A



FISHER RADIO CORPORATION • NEW YORK

NI 020-103 GX

PRINTED IN U.S.A.

IIGM

(c) www.fisherconsoles.com